

MOLDED POWER CHOKE COIL

PIB0605M SERIES

1. PART NO. EXPRESSION :

PIB0605M 2R2MN - □ □

(a) (b) (c) (d) (e)(f) (g)

(a) Series code
(b) Dimension code
(c) Type code

(d) Inductance code : 2R2 = 2.2uH
(e) Tolerance code : M = ± 20%, Y = ± 30%
(f) No coating
(g) Internal control number : 11 ~ 99

2. CONFIGURATION & DIMENSIONS :

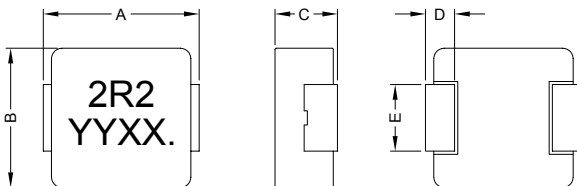

Unit:m/m

A	B	C	D	E
7.3±0.3	6.6 ±0.2	4.8±0.2	1.8±0.3	3.0±0.3

3. SCHEMATIC :

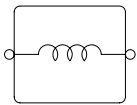

4. MATERIALS :

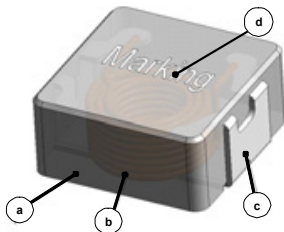

(a) Core : Alloy metal powder or equivalent
(b) Wire : Polyester wire or equivalent
(c) Solder Plating : 100% Pb free solder
(d) Ink : Halogen-free ketone

5. GENERAL SPECIFICATION :

- Test Freq. : L : 100KHz/1V
- Ambient Temp. : 25° C
- Operating Temp. : -40° C to +125° C
- Storage Temp. : -10° C to +40° C
- Humidity Range : 50 ~ 60% RH (Product without taping)
- Heat Rated Current (Irms) : Will cause the coil temp. rise approximately Δt of 40°C (keep 1min.)
- Saturation Current (Isat) : Will cause L0 to drop 30% typical (keep quickly)
- Part Temperature (Ambient+Temp. Rise) : Should not exceed 125° C under worst case operating conditions.



RoHS Compliant

NOTE : Specifications subject to change without notice. Please check our website for latest information.



SUPERWORLD ELECTRONICS (S) PTE LTD

31.03.2011

6. ELECTRICAL CHARACTERISTICS :

Part No.	Inductance L _o (μ H) @ 0 A	I _{rms} (A) Typ.	I _{sat} (A) Typ.	DCR (m Ω) Typ. @ 25° C	DCR (m Ω) Max. @ 25° C
PIB0605MR36MN	0.36 \pm 20%	21	25	2.85	3.5
PIB0605MR56MN	0.56 \pm 20%	18	18	3.4	3.6
PIB0605MR68MN	0.68 \pm 20%	16	16	3.9	4.2
PIB0605MR82MN	0.82 \pm 20%	16.5	17	4.6	4.9
PIB0605M1R0MN	1.00 \pm 20%	13	15	5.6	6.5
PIB0605M1R5MN	1.50 \pm 20%	11	12	6.7	7.5
PIB0605M2R2MN	2.20 \pm 20%	8	10	10.2	11.7
PIB0605M3R3MN	3.30 \pm 20%	7.0	9.0	19.0	20.9
PIB0605M4R7MN	4.70 \pm 20%	6.5	7.0	23.0	25.0
PIB0605M8R2MN	8.20 \pm 20%	5.5	6.0	38.0	43.0
PIB0605M100MN	10.0 \pm 20%	4.5	5.5	51	55

7. CHARACTERISTICS CURVES :

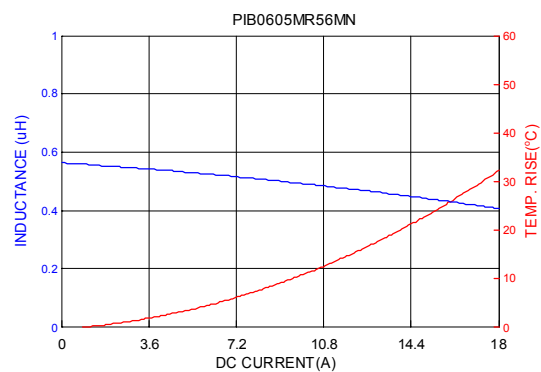
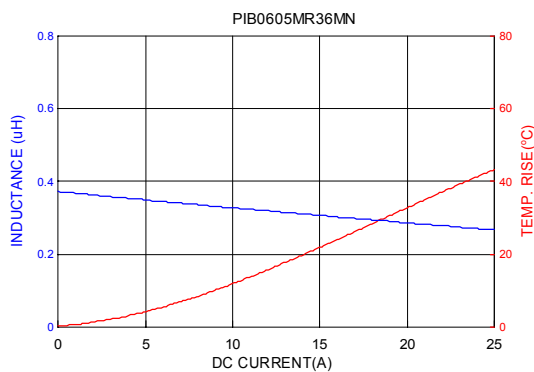

RoHS Compliant

NOTE : Specifications subject to change without notice. Please check our website for latest information.

31.03.2011



SUPERWORLD ELECTRONICS (S) PTE LTD

7. CHARACTERISTICS CURVES :

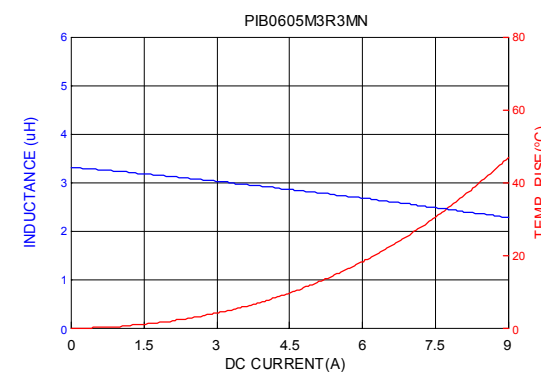
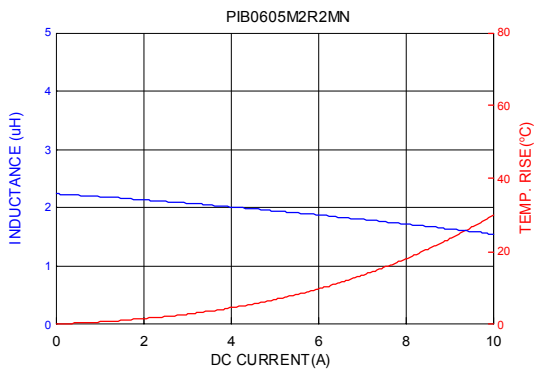
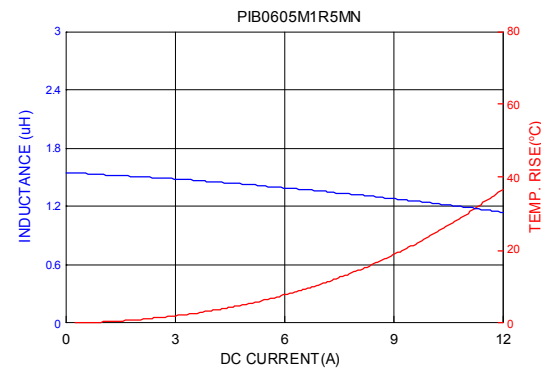
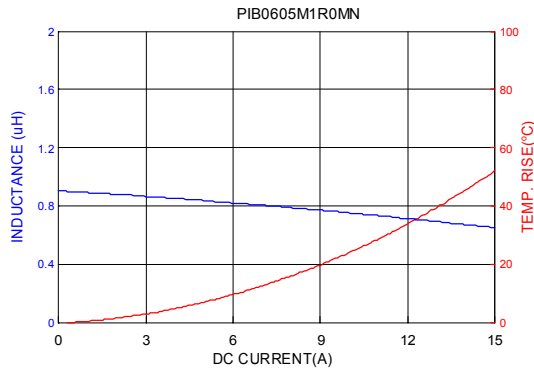
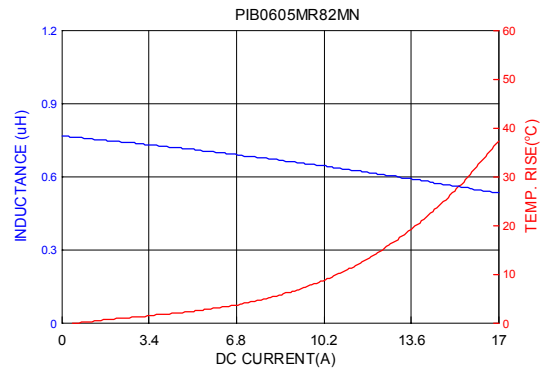
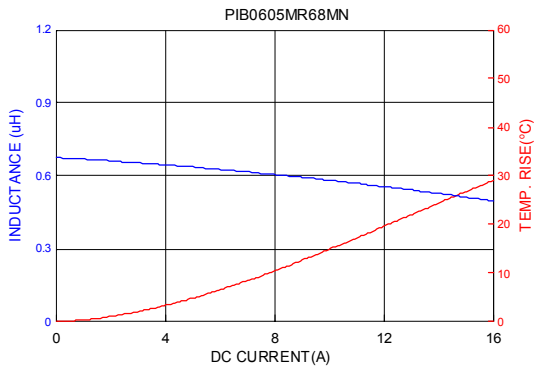

RoHS Compliant

NOTE : Specifications subject to change without notice. Please check our website for latest information.

31.03.2011



SUPERWORLD ELECTRONICS (S) PTE LTD

7. CHARACTERISTICS CURVES :

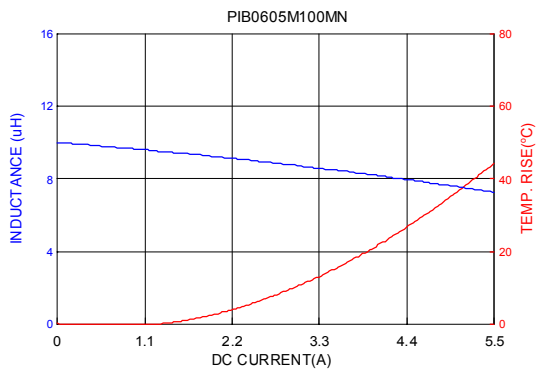
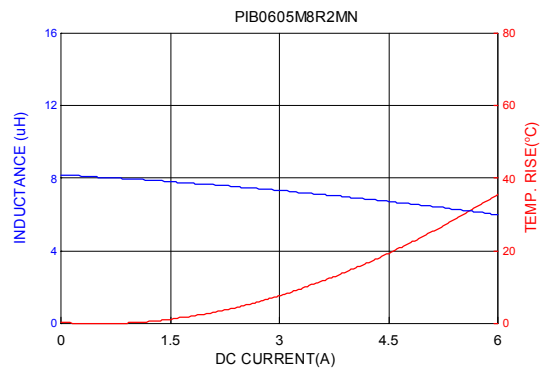
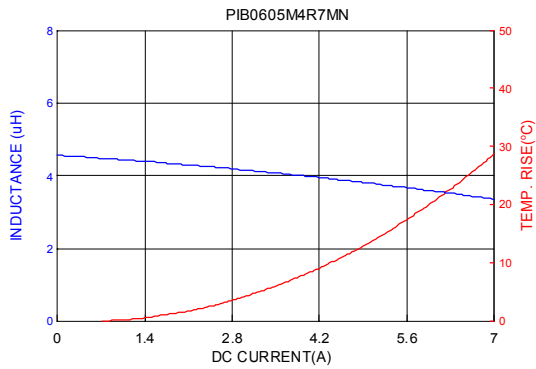

RoHS Compliant

NOTE : Specifications subject to change without notice. Please check our website for latest information.

31.03.2011



SUPERWORLD ELECTRONICS (S) PTE LTD

8. RELIABILITY AND TEST CONDITION

ITEM	PERFORMANCE	TEST CONDITION												
Electrical Characteristics Test														
Inductance	Refer to standard electrical characteristics list	HP4284A, CH11025, CH3302, CH1320, CH1320S LCR meter.												
DCR		CH16502, Agilent33420A Micro-Ohm Meter.												
Heat Rated Current (Irms)		Irms(A) will cause the coil temperature rise approximately ΔT of 40°C without core loss 1. Applied the allowed DC current(keep 1min). 2. Temperature measured by digital surface thermometer												
Saturation Current (Isat)	ΔL 30% typical	Isat(A) will cause Lo to drop												
Reliability Test														
High Temperature Test	Electric specification should be satisfied	Temperature : 125± 2° C Time : 1000± 12hrs Measured at room temperature after placing for 2 to 3hrs (MIL-PRF-27)												
Low Temperature Test		Temperature : -40± 2° C Time :500± 12hrs Measured at room temperature after placing for 2 to 3hrs												
Thermal Shock		Conditions of 1 cycle. <table border="1"> <thead> <tr> <th>Step</th> <th>Temperature (° C)</th> <th>Times (min.)</th> </tr> </thead> <tbody> <tr> <td>1</td> <td>-40+0/-2</td> <td>15± 1</td> </tr> <tr> <td>2</td> <td>Room Temperature</td> <td>Within ≤ 0.2</td> </tr> <tr> <td>3</td> <td>+125+2/-0</td> <td>15± 1</td> </tr> </tbody> </table> Total : 300 cycles Measure at room temperature after placing for 2 to 3 hrs. (AEC-Q200-REV C)	Step	Temperature (° C)	Times (min.)	1	-40+0/-2	15± 1	2	Room Temperature	Within ≤ 0.2	3	+125+2/-0	15± 1
Step		Temperature (° C)	Times (min.)											
1		-40+0/-2	15± 1											
2		Room Temperature	Within ≤ 0.2											
3		+125+2/-0	15± 1											
Humidity Resistance	Temperature : 85± 2° C Humidity : 85± 3% RH Time : 1000± 12hrs Measured at room temperature after placing for 2 to 3hrs (AEC-Q200-REV C)													
Random Vibration Test	Frequency : 10-2000-10Hz for 20 min. Amplitude: Parts mounted within 2" from any secure point Directions and times : X, Y, Z directions for 20 min. This cycle shall be performed 12 times in each of three mutually perpendicular directions. (Total 12hours). (MIL-STD-202 Method 204 D Test condition B)													
Reflow Test	Preheat : 150± 5° C Duration : 5 minutes Temperature : 260± 5° C, 20-40 seconds (IPC/JEDEC J-STD-020C)													
Solder test	Terminals should be covered by over 95% solder on visual inspection.	After dip into flux, dip into solder 235± 5° C, 4± 1seconds Flux, solder for lead free (ANSI/J-STD-002C Method B)												



RoHS Compliant

NOTE : Specifications subject to change without notice. Please check our website for latest information.

31.03.2011



SUPERWORLD ELECTRONICS (S) PTE LTD

9. SOLDERING AND MOUNTING :

9-1. Recommended PC Board Pattern

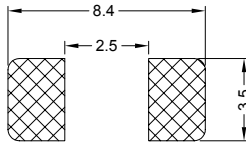

9-2. Soldering

Mildly activated rosin fluxes are preferred. The minimum amount of solder can lead to damage from the stresses caused by the difference in coefficients of expansion between solder, chip and substrate. Our terminations are suitable for all wave and re-flow soldering systems. If hand soldering cannot be avoided, the preferred technique is the utilization of hot air soldering tools.

9-2.1 Solder Re-flow :

Recommended temperature profiles for re-flow soldering in Figure 1.

9-2.2 Soldering Iron (Figure 2) :

Products attachment with soldering iron is discouraged due to the inherent process control limitations. In the event that a soldering iron must be employed the following precautions are recommended.

Note :

- Preheat circuit and products to 150° C.
- 355° C tip temperature (max)
- Never contact the ceramic with the iron tip
- 1.0mm tip diameter (max)
- Use a 20 watt soldering iron with tip diameter of 1.0mm
- Limit soldering time to 4-5 secs.

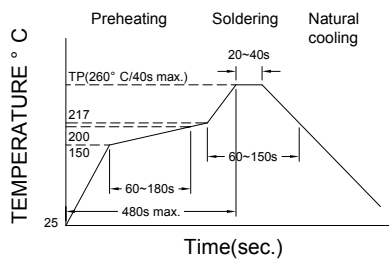

Figure 1. Re-flow Soldering

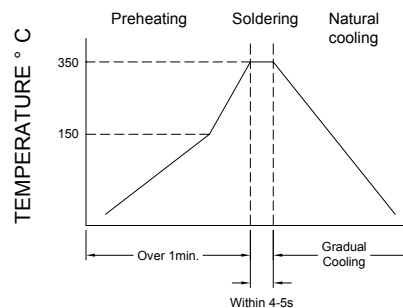

Figure 2. Iron Soldering



RoHS Compliant

NOTE : Specifications subject to change without notice. Please check our website for latest information.



SUPERWORLD ELECTRONICS (S) PTE LTD

31.03.2011

10. PACKAGING INFORMATION :

10-1. Reel Dimension

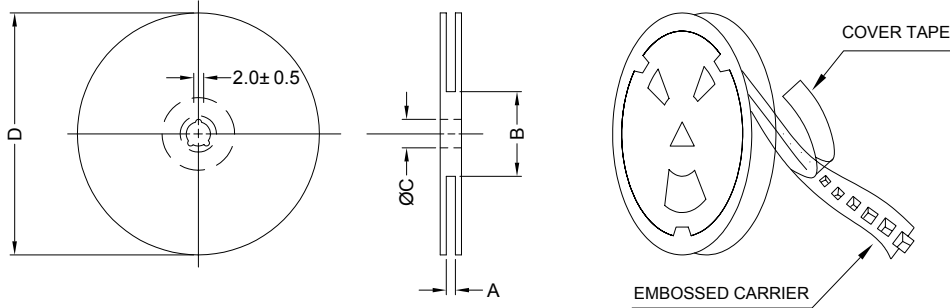

Type	A(mm)	B(mm)	C(mm)	D(mm)
13" x 16mm	16.0±0.5	100±2.0	13.5±0.5	330

10-2 Tape Dimension

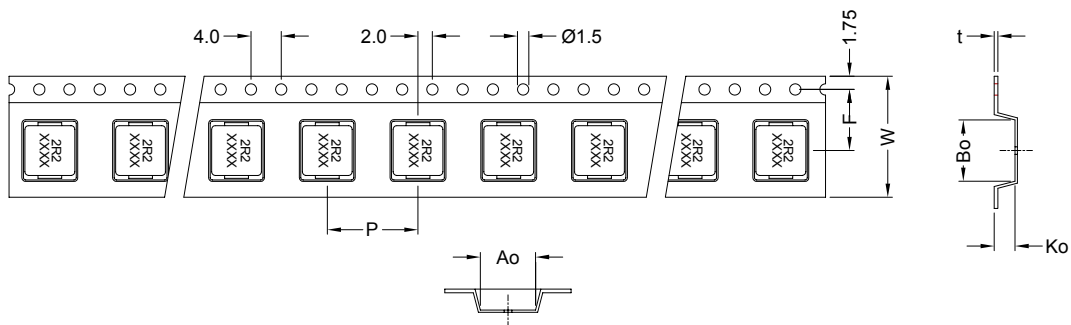

Series	Ao(mm)	Bo(mm)	Ko(mm)	P(mm)	W(mm)	F(mm)	t(mm)
PIB0605M	7.0±0.1	7.7±0.1	5.3±0.1	12.0±0.1	16.0±0.3	7.5±0.1	0.35±0.05

10-3. Packaging Quantity

Size	0605
Chip / Reel	800
Inner Box	1600
Carton	6400



RoHS Compliant

NOTE : Specifications subject to change without notice. Please check our website for latest information.



10-4. Tearing Off Force

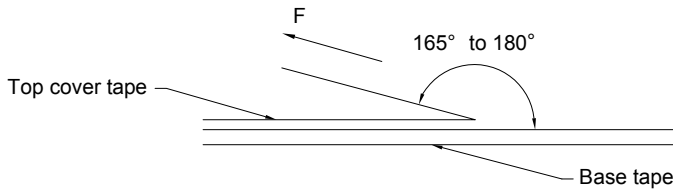

The force for tearing off cover tape is 10 to 130 grams in the arrow direction under the following conditions. (referenced ANSI/EIA-481-C-2003 of 4.11 standard)

Room Temp. (° C)	Room Humidity (%)	Room atm (hPa)	Tearing Speed (mm/min)
5~35	45~85	860~1060	300

Application Notice

1. Storage Conditions :

To maintain the solderability of terminal electrodes :

- Temperature and humidity conditions : Less than 30° C and 70% RH.
- Recommended products should be used within 6 months from the time of delivery.
- The packaging material should be kept where no chlorine or sulfur exists in the air.

2. Transportation :

- Products should be handled with care to avoid damage or contamination from perspiration and skin oils.
- The use of tweezers or vacuum pick up is strongly recommended for individual components.
- Bulk handling should ensure that abrasion and mechanical shock are minimized.



RoHS Compliant

NOTE : Specifications subject to change without notice. Please check our website for latest information.

31.03.2011



SUPERWORLD ELECTRONICS (S) PTE LTD

PG. 8